

FRAJUMAR®

Handmade  
Upholstery in

SPAIN

Style Culture since 1967

## **FRAJUMAR** Calidad, Investigación y Tradición

En 1967, Francisco Juan Martínez funda Frajumar. Empresa familiar guiada por un espíritu dinámico que apuesta por la calidad, la innovación y el diseño. Enfocada a la realización de un producto atemporal sin olvidar el saber tradicional gracias a su dilatada experiencia. Crea su primera colección de mobiliario con el objetivo de satisfacer plenamente las necesidades de la vida contemporánea.

Actualmente, el fin sigue siendo el mismo, cada producto debe mantener una relación de armonía con todo aquello que le rodea, los lugares donde se utiliza y las personas que lo van a utilizar.

Frajumar está presente en más de treinta países y sólo fabrica en Europa bajo un Sistema de Gestión de Calidad ISO 9001 certificado por la compañía internacion Bureau Veritas.

Como resultado de este trabajo, ahora tiene en sus manos parte de nuestra historia.

## **FRAJUMAR** Quality, Research & Tradition

*Back in 1967 Mr. Francisco Juan Martínez was the founder of Frajumar. It is a family business guided by a dynamic spirit and committed with quality, innovation and design. Focused to create timeless pieces together with a traditional know-how due his large experience. His first furniture collection was created to achieve the needs of contemporary life style.*

*Nowadays, goal remains the same, each product must keep a harmony with elements surrounding, place to be and people who will use them.*

*Frajumar is present in over 30 countries and only manufacture in Europe under Quality Management System ISO 9001 certified by international Bureau Veritas.*

*As a result of that job, you can now hold in your hands a part of our history.*

## **FRAJUMAR** Qualité, Recherche et Tradition

À 1967, Francisco Juan Martínez a fondé Frajumar. Guidé par un esprit dynamique, cette entreprise familiale mise par la qualité, l'innovation et le design. Envisage à la réalisation d'un produit intemporel, sans oublier les savoirs traditionnels grâce à sa vaste expérience. Il a créé sa première collection de meubles dans le but de satisfaire pleinement les besoins de la vie contemporaine.

Actuellement, l'objectif reste le même, chaque produit doit maintenir une relation d'harmonie avec tout ce qui l'entoure, les endroits où il est utilisé et les gens qu'ils utiliseront.

Frajumar est présent dans plus de trente pays et seulement fabriqué en Europe selon le Système de Management de la Qualité ISO 9001, certifié par la société International Bureau Veritas.

À la suite de ce travail, vous avez maintenant dans ses mains une partie de notre histoire.



Mr. Francisco Juan Martínez, founded Frajumar in 1967

# INDEX

## SOFA



Baco 50\_Tc 96



Basik 20\_Tc 96



Codi 40\_Tc 97



Cool 34\_Tc 97



Demo 42\_Tc 98



Desk 48\_Tc 98



Egos 30\_Tc 99



Emuc 16\_Tc 99



Lieb 4\_Tc 100



Lime 12\_Tc 100



Lobi 24\_Tc 101



Mare 53\_Tc 101



Modo 38\_Tc 102



Musa 54\_Tc 102



Myma 58\_Tc 103



Nimo 26\_Tc 103



Noha 32\_Tc 105



Novo 44\_Tc 104



Numa 60\_Tc 104



Sima 36\_Tc 105



Soul 8\_Tc 105



Voll 62\_Tc 106



Font 65\_Tc 106

## SOFA BED



Eroc 66\_Tc107



Nice 68\_Tc107



## ARMCHAIR



Adoc 75\_Tc 108



Alma 70\_Tc 108



Alza 77\_Tc 108



City 71\_Tc 108



Iova 74\_Tc 109



Lase 73\_Tc 109



Maya 78\_Tc 109



Nawa 80\_Tc 109



Ofre 72\_Tc 110



Salo 76\_Tc 110



Tomo 79\_Tc 110



Vina 81\_Tc 110

## TABLE



Alo 82\_Tc 112



Gib 85\_Tc 112



Par 83\_Tc 112



Tak 84\_Tc 113



Tip 86\_Tc 113



Zar 87\_Tc 113

## RECLINER



Soul 8\_Tc 105



Voll 62\_Tc 106



Font 65\_Tc 106

## COMPLEMENT



Cube 88\_Tc 111



Prai TRAY 89\_Tc 111



Easy - Cushions 89\_Tc 111

FINISHES .....	90
FABRICS .....	91
TECHNICAL .....	96
PROJECTS .....	114
SHOWROOM .....	118
WEB-ENVIROMENT .....	120
AWARDS-QUALITY .....	121



LIEB sofa, canapé. ALO mesa, table. ISEN mesita, side table.



LIEB sofa, canapé. LASE butaca, armchair, fauteuil. ALO mesa, table. ISEN mesita, side table.



SOUL sofá, canapé. CITY butaca, armchair, fauteuil. PAR mesa, table. FRES mesita, side table.



SOUL sofa, canapé. CITY butaca, armchair, fauteuil. PAR mesa, table. FRES mesita, side table.



LIME sofa, canapé. OFRE butaca, armchair, fauteuil. AGOL mesa, table. BACK mesita, side table.





LIME sofa, canapé. OFRE butaca, armchair, fauteuil. AGOL mesa, table.



EMUC sofa, canapé. SALO butaca, armchair, fauteuil. ALMA butaca, armchair, fauteuil. RUND mesa, table. FRES mesita, side table.



EMUC sofa, canapé. SALO butaca, armchair, fauteuil. RUND mesa, table. FRES mesita, side table.



BASIK sofa, canapé. CITY butaca, armchair, fauteuil. PAR mesa, table.



BASIK sofa, canapé. CITY butaca, armchair, fauteuil. PAR mesa, table.



OP.1



OP.2



LOBI sofa, canapé. GIB mesa, table.





NIMO sofa, canapé. IOVA butaca, armchair, fauteuil. ZAR mesa, table. CUBE pouf, stool.





EGOS sofa, canapé. LASE butaca, armchair, fauteuil. CUBE pouf, stool.



NOHA sofa, canapé. GIB mesa, table. PRAI bandeja, tray, plateau.



COOL Op.1, sofa, canapé.



COOL Op.2, sofa, canapé. 



SIMA sofa, canapé. GIB mesa, table.



Op.1



Ref. 156B1

Op.2



Ref. 156B3



MODO sofa, canapé. GIB mesa, table.





CODI sofa, canapé.



DEMO sofa, canapé.



NOVO sofa, canapé. ALMA, butaca, armchair, fauteuil. GIB mesa, table.





NOVO sofa, canapé.



DESK sofa, canapé. ALMA, butaca, armchair, fauteuil. GIB mesa, table.



BACO sofa, canapé. PAR mesa, table.



MARE sofa, canapé. GIB mesa, table. TAK mesita, side table. CUBE pouf, stool.





MUSA sofa, canapé (Op.2 and removable). EVEN mesa, table. POK mesita, side table.



MUSA sofa, canapé (Op.1). ADOC, butaca, armchair, fauteuil. TIP crystal, mesa, table. CUBE, pouf, stool.



MYMA sofa, canapé. IOVA, butaca, armchair, fauteuil. ZAR, mesa, table.







VOLL sofa, canapé. VOLL, butaca, armchair, fauteuil. ALO, mesa, table. RUND, mesita, side table.





OP1



OP2



OP3



OP4





NICE sofa - bed, convertible.





Ref. 194BU



Ref. 935BU



Ref. 935BZ



Ref. 194BZ



Ref. 935BC



Ref. 913BU



Ref. 328BU



Ref. 328BC



Ref. 913BZ



Ref. 328BZ



IOVA, design Arbel



ADOC, design Arbel



SALO, design Arbel



ALZA, design Arbel





MAYA, design Arbel



TOMO, design Arbel



NAWA, design Arbel

VINA, design Eduardo Climent





TAK, design Arbel



GIB, design Arbel





Ref: 199RE  
50 cm

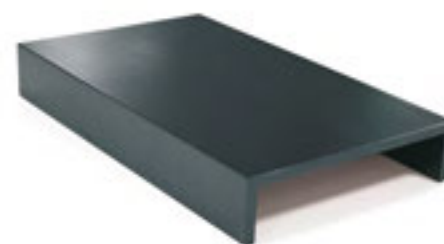

PRAI  
bandeja, tray, plateau



HEADREST,  
almohada cabezal, tête.ère.



Ref: 199CO  
45x45 cm



CUSHIONS, cojines, cuscini. Design Arbel



Ref: 141CO  
45x45 cm



Ref: 190CO  
37x47 cm



Ref: 195CO  
45x45 cm



Ref: 934CO  
45x45 cm



Ref: 913CO  
27x50 cm



Ref: 184CO  
45x45 cm

**ACABADOS / FINISHES / FINITIONS**

**MADERA / WOOD / BOIS**



**WENGUE**  
OAK  
CHÊNE

**ROBLE**  
OAK  
CHÊNE

**CEREZO**  
CHERRY  
MERISIER

**FRESNO**  
ASH  
CENDRE

**NOGAL**  
WALNUT  
NOYER

**HAYA**  
BEECH  
HÊTRE

**SICOMORO**  
SYCAMORE  
SYCOMORE

**ACERO / STEEL / ACIER**



**ACERO INOX**  
STAINLESS STEEL  
ACIER INOX

**CROMADO**  
CHROMED  
CHOROMÉ

**NEGRO**  
BLACK  
NOIR

**BLANCO**  
WHITE  
BLANC

**PAN DE PLATA**  
SILVER LEAF  
ARGENT

**PAN DE ORO**  
GOLD LEAF  
OR

**LACADO / PAINTED / PEINTURE**



**PIEDRA**  
STONE  
PIERRE

**GRIS**  
GREY

**MAR**  
SEA  
MER

**VERDE**  
GREEN  
VERT

**FUCSIA**  
FUCHSIA

**NARANJA**  
ORANGE



**NEGRO**  
BLACK  
NOIR

**BLANCO**  
WHITE  
BLANC

**ROJO**  
RED  
ROUGE

**NEGRO BRILLO**  
SHINE BLACK  
NOIR BRILLIANT

**BLANCO BRILLO**  
SHINE WHITE  
BLANC BRILLIANT

**CHOCOLATE BRILLO**  
SHINE CHOCOLAT  
CHOCOLAT BRILLIANT

**CRISTAL / CRYSTAL / VERRE**



**TRANSPARENTE**  
TRANSPARENT

**BLANCO**  
WHITE  
BLANC

**NEGRO**  
BLACK  
NOIR

**MARMOL / MARBLE / MARBRE**

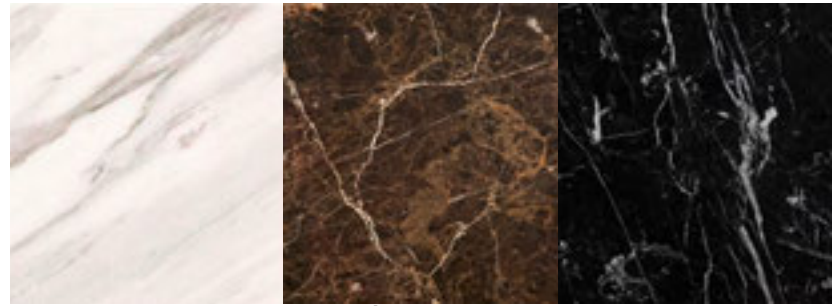

**BLANCO**  
WHITE  
BLANC

**MARRÓN IMPERIAL**  
BROWN  
BRUN

**NEGRO**  
BLACK  
NOIR

**TEJIDOS / FABRICS / TISSUS**

PROVEEDOR SUPPLIER FOURNISSEUR	COLECCION COLECTION	SERIE
<b>PIELES-PVC LEATHER-PVC CUIR-PVC</b>		
MARIANO FARRUGIA	STAR CIERVO SAVANA	PVC+PIEL STAR 4 PIEL CIERVO 8 SAVANA 8
ALONSO MERCADER		STAR 2 MAXIUM 3 RX 2 GRAIM 2 FLOR 2
SPRADLING CONTRACT-PROJECT		SILVERTEX 4 VALENCIA 3 DOLCE 5 VOGUE 4

PROVEEDOR SUPPLIER FOURNISSEUR	COLECCION COLECTION	SERIE
<b>TELAS FABRICS TISSUS</b>		
CREVIN	Divine - Zip - Ri ZIP, RITUAL TEXTURAS	DUO 2 DAS 2 MOSAIC 2 PLANA 2 SCOTH 2 YORK 2 ZIP 2 KRAC 2 VIBRANT 2 BRICKS 3 DROM 3 MIRAGE 3 DIVINE 3 PRISMA 3 TETRA 3 SUBLIM 3
ARTEMPO	FASHION COLONIAL	2
INTERFABRIC	VISUAL TEXTURES	3

PROVEEDOR SUPPLIER FOURNISSEUR	COLECCION COLECTION	SERIE
GÜELL-LA MADRID LE-CREATIONS	CONSULTAR CON FÁBRICA CONSULT WITH US CONSULTER AVEC L'USINE	

PROVEEDOR SUPPLIER FOURNISSEUR	COLECCION COLECTION	SERIE
CASAMANCE	CONSULTAR CON FÁBRICA CONSULT WITH US CONSULTER AVEC L'USINE	

PARA OTRAS REFERENCIAS DE ESTOS U OTROS PROVEEDORES EN LOS QUE ESTÉ INTERESADO CONSULTAR EN FÁBRICA.  
 FOR OTHER REFERENCES OF THOSE OR OTHER SUPPLIERS IN WICH YOU COULD BE INTERESTED CONSULT WITH US.  
 POUR D'AUTRES RÉFÉRENCES DE SES FOURNISSEURS SI NOUS ÊTES INTÉRESSÉS, CONSULTER AVEC L'USINE.

PROVEEDOR SUPPLIER FOURNISSEUR	COLECCION COLECTION	SERIE
<b>TELAS FABRICS TISSUS</b>		
RUSTIKA	ALWAYS NOW TOMORROW	2
COIRO	NIRVANA	2
TEXTIL ROIG	CLICK FLASH	CLICK 1 PICASSO 2 FLASH 2

PROVEEDOR SUPPLIER FOURNISSEUR	COLECCION COLECTION	SERIE
CREVIN	ZIP, RITUAL TEXTURAS	DUO 2 DAS 2 MOSAIC 2 PLANA 2 SCOTH 2 YORK 2 ZIP 2 KRAC 2 VIBRANT 2 BRICKS 3 DROM 3 MIRAGE 3 DIVINE 3 PRISMA 3 TETRA 3 SUBLIM 3
FROCA	ARREDO MAMUT TEXTURES	TOUAREG 2 TORNADO 2 NAPA 2 NILO 2 LIVORNO 2 ARREDO 2 MAMUT 2 MASTIFF 1 POINTER 1 HARRIER 1 SHOWA 1 ESTEPA 1

PROVEEDOR SUPPLIER FOURNISSEUR	COLECCION COLECTION	SERIE
ARTEMPO	FASHION COLONIAL	2

PROVEEDOR SUPPLIER FOURNISSEUR	COLECCION COLECTION	SERIE
INTERFABRIC	VISUAL TEXTURES	3
CABANES & ORTUÑO	COOL	2

PARA OTRAS REFERENCIAS DE ESTOS U OTROS PROVEEDORES EN LOS QUE ESTÉ INTERESADO CONSULTAR EN FÁBRICA.  
 FOR OTHER REFERENCES OF THOSE OR OTHER SUPPLIERS IN WICH YOU COULD BE INTERESTED CONSULT WITH US.  
 POUR D'AUTRES RÉFÉRENCES DE SES FOURNISSEURS SI NOUS ÊTES INTÉRESSÉS, CONSULTER AVEC L'USINE.

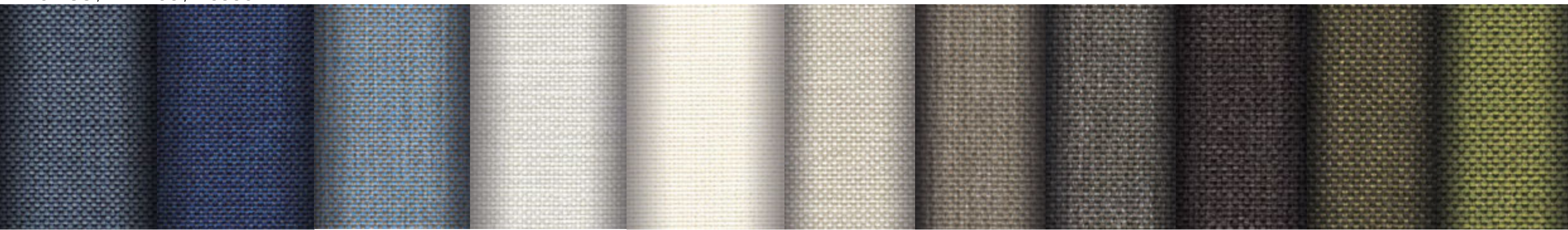

S-2 5100 denim    S-2 5101 navy    S-2 5102 ocean    S-2 5103 ivory    S-2 5104 beige    S-2 5105 linem    S-2 5106 wood    S-2 5107 expresso    S-2 5108 chocolate    S-2 5109 olive    S-2 5110 pistacho

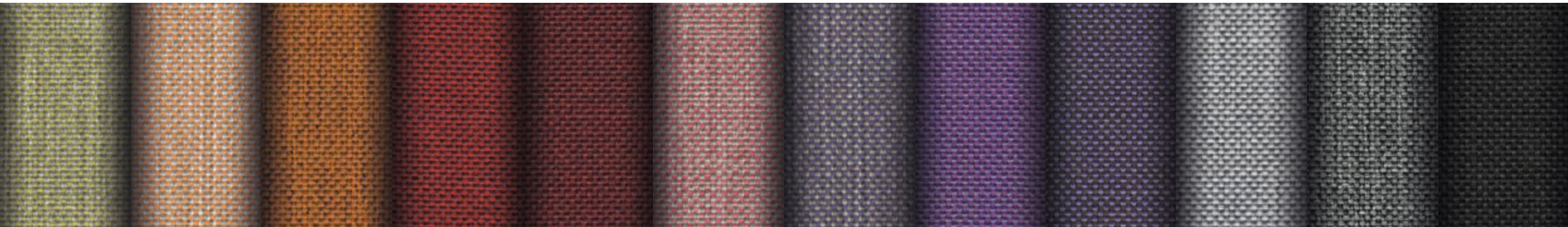

S-2 5111 green    S-2 5112 blush    S-2 5113 orange    S-2 5114 red    S-2 5115 coral    S-2 5116 wine red    S-2 5117 prune    S-2 5118 violet    S-2 5119 purple    S-2 5120 lightgrey    S-2 5121 grey    S-2 5122 antracite

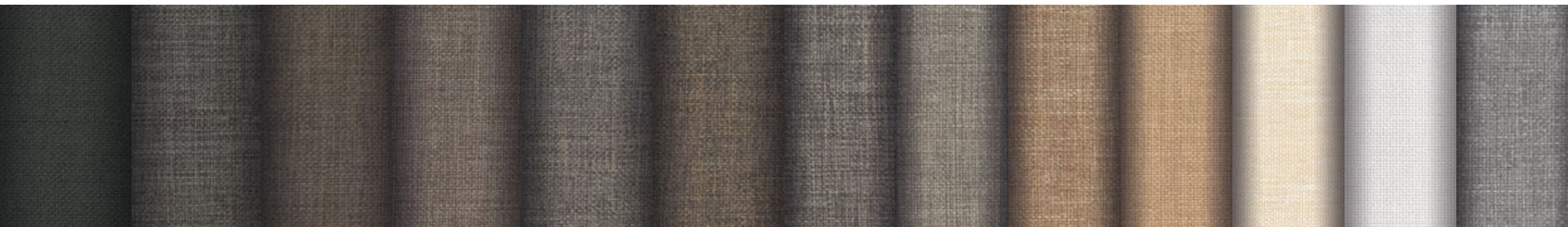

S-2 5156 chocolate    S-2 5157 expresso    S-2 5158 coffee    S-2 5159 cacao    S-2 5160 liver    S-2 5161 brown    S-2 5162 taupe    S-2 5163 kaki    S-2 5164 beige    S-2 5165 sand    S-2 5166 ecru    S-2 5167 evory    S-2 5168 lightgrey

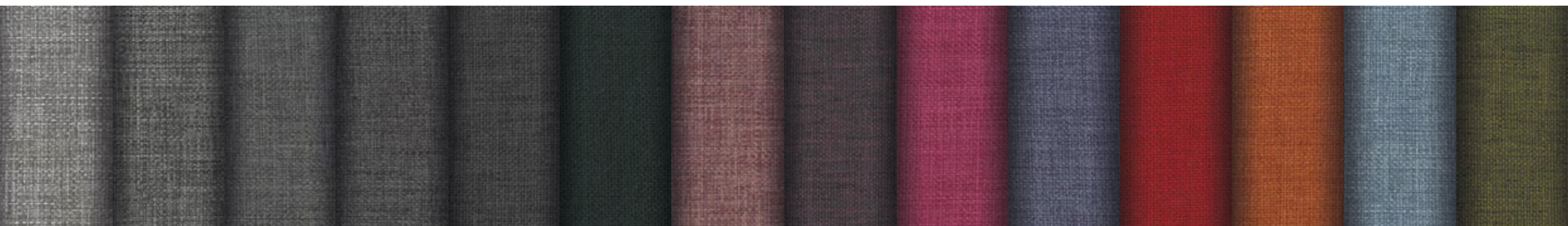

S-2 5169 dolphin    S-2 5170 plumb    S-2 5171 anthracite    S-2 5172 darkgrey    S-2 5173 graphite    S-2 5174 onyx    S-2 5175 aubergine    S-2 5176 purple    S-2 5177 pink    S-2 5178 lavender    S-2 5179 red    S-2 5180 orange    S-2 5181 oceanblue    S-2 5182 green





**S - 2**  
**5123** *desert*      **S - 2**  
**5124** *beige*      **S - 2**  
**5125** *espresso*      **S - 2**  
**5126** *chocolate*      **S - 2**  
**5127** *white*      **S - 2**  
**5128** *dolphin*      **S - 2**  
**5129** *grey*      **S - 2**  
**5130** *anthracite*      **S - 2**  
**5131** *graphite*      **S - 2**  
**5132** *hunter*      **S - 2**  
**5133** *aqua*      **S - 2**  
**5134** *indigo*



**S - 1**  
**2600** *natural*      **S - 1**  
**2601** *khaki*      **S - 1**  
**2602** *taupe*      **S - 1**  
**2603** *espresso*      **S - 1**  
**2604** *onyx*      **S - 1**  
**2605** *graphite*      **S - 1**  
**2606** *grey*      **S - 1**  
**2607** *dolphin*      **S - 1**  
**2608** *nightsade*      **S - 1**  
**2609** *violet*      **S - 1**  
**2610** *navy*      **S - 1**  
**2611** *petrol*      **S - 1**  
**2612** *pistacho*      **S - 1**  
**2613** *mustard*      **S - 1**  
**2614** *brick*      **S - 1**  
**2615** *scarlet*



**S - 2**  
**5135** *nightside*      **S - 2**  
**5136** *magnolia*      **S - 2**  
**5137** *burgundy*      **S - 2**  
**5138** *mandarin*      **S - 2**  
**5139** *lime*      **S - 2**  
**5140** *sun*      **S - 2**  
**5141** *mango*      **S - 2**  
**5142** *petrol*      **S - 2**  
**5143** *denim*      **S - 2**  
**5144** *chocolate*      **S - 2**  
**5145** *hunter*      **S - 2**  
**5146** *liver*      **S - 2**  
**5147** *khaki*      **S - 2**  
**5148** *sand*

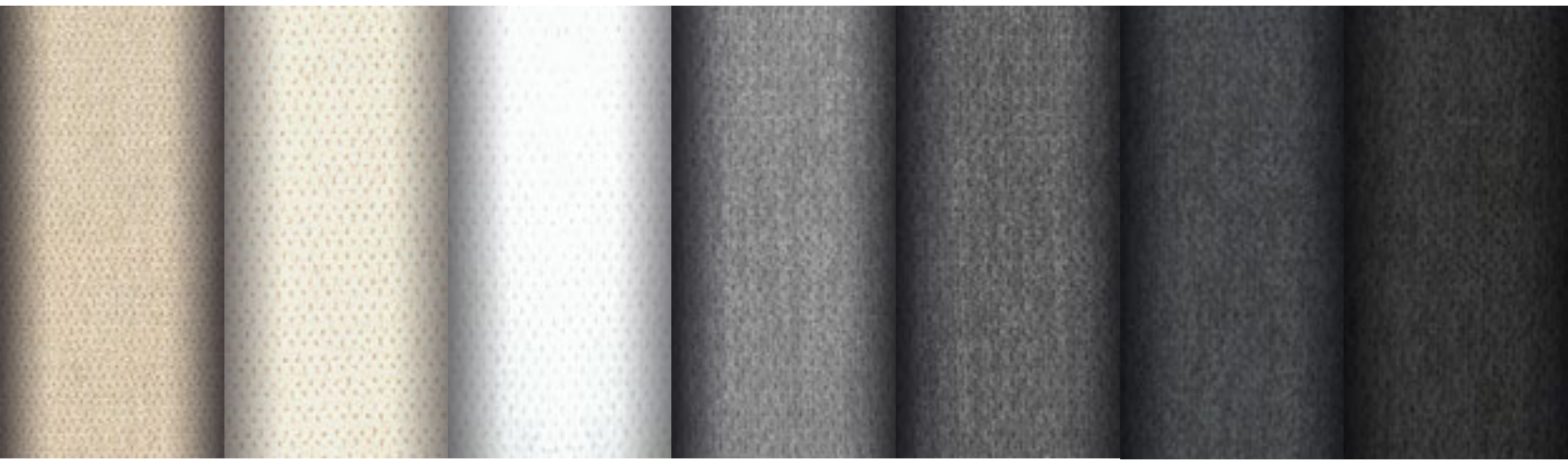

**S - 2**  
**5149** *beige*      **S - 2**  
**5150** *cream*      **S - 2**  
**5151** *white*      **S - 2**  
**5152** *dolphin*      **S - 2**  
**5153** *grey*      **S - 2**  
**5154** *antracite*      **S - 2**  
**5155** *graphite*

References	Width	Composition	Martindale	Cleaning
S - 2 5100 a 5200	140 cm	50% PP 31%PES 19%CO	32500 cycles	Efficiency®
S - 2 5100 a 5200	143 cm	100%PES	100000 cycles	Teflon
S - 2 5100 a 5200	140 cm	100%CO	30000 cycles	
S - 2 5100 a 5200	138 cm	96%PES 4%NY	45000 cycles	
S - 1 5100 a 5200	145 cm	100%PES	70000 cycles	

Los colores de los tejidos, polipiel y pieles pueden variar de una partida a otra. / The colors of the fabrics, synthetic leather and leather may differ from one consignment to the next. / Les couleurs des tissus, des cuirs synthétiques et des cuirs, ils peuvent varier d'une commande à une autre.

## BACO

50-51

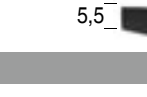
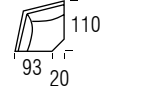
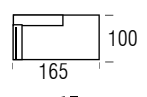
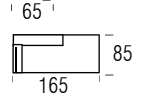
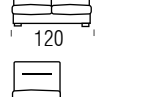
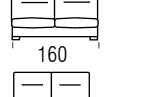
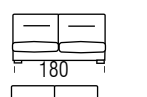
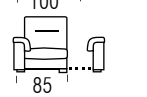
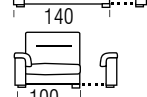
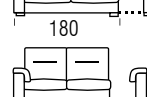
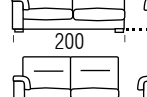
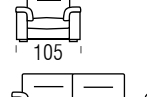
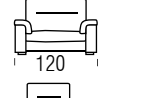
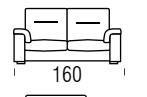
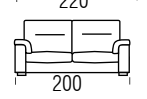
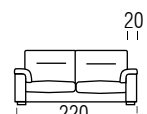
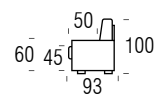

REF.

1424P

1423P

1422P

142EP

1421P

142M4

142M3

142M2

142ME

142M1

1424S

1423S

1422S

142ES

1421S

142CH

142CS

142RI

\*Fabric model shown S-2

### OPCIONES / OPTIONS / OPTIONS

#### PATAS / LEGS / PIEDES

3,5 P-23 5,5 P-25

#### ASIENTOS / SEATS / ASSISE

PLUMÓN DOWN TOUCH TACT DUVET VISCOELÁSTICA VISCOELASTIC

#### DESGLIZANTE / SLIDING / AMOVIBLE

- Asiento y respaldo deslizante manual.
- Manual sliding system for seat and back.
- Assise et dossier amovible manual.

- Deslizante mediante mecanismo automático con botonera cromada o mando inalámbrico.
- Automatic sliding system, with chromed buttons or remote control.
- Coulissant avec mécanisme électrique ayant deux options : boutonnière chromée ou télécommande.

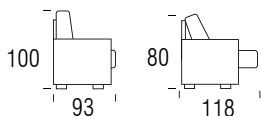

## BASIK

20-23

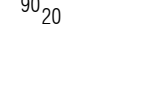
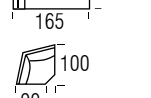
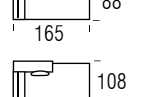
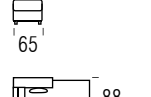
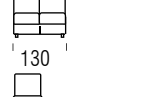
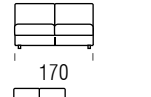
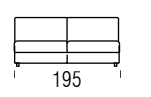
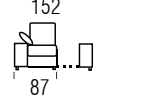
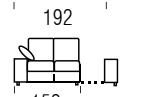
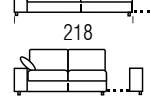
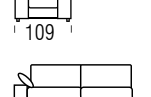
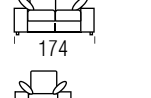
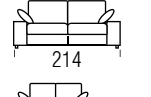
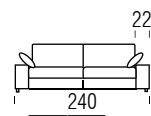
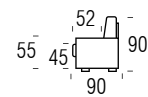

REF.

1844P

1843P

1842P

1841P

184M4

184M3

184M2

184M1

1844S

1843S

1842S

1841S

184CH

184CS

184RI

\*Fabric model shown S-2

### OPCIONES / OPTIONS / OPTIONS

#### PATAS / LEGS / PIEDES

3,5 P-23 5,5 P-25 4 P-42

HIDE / OCULTA

#### ACABADOS / FINISHES / FINITIONS

P-25	P-42	WENGUE	
P-25		CEREZO	CHERRY
		ROBLE	OAK
P-23		CROMADO	CHROMED
			CHROMÉ

## CODI

40-41

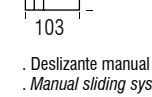
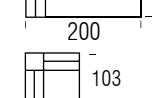
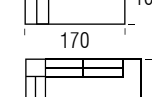
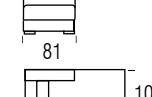
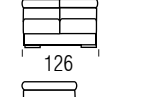
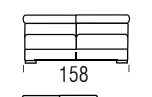
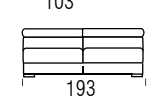
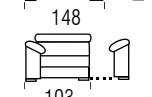
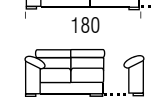
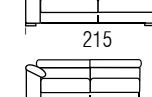
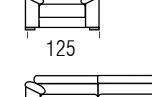
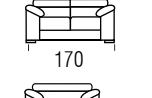
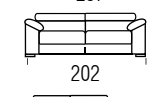
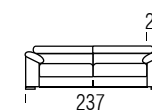
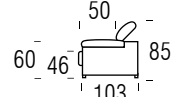
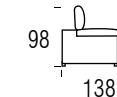
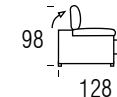
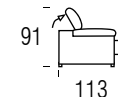

REF.

1804P

1803P

1802P

1801P

180M4

180M3

180M2

180M1

1804S

1803S

1802S

1801S

180CH

180CR

180RI

\*Fabric model shown S-2

### OPCIONES / OPTIONS / OPTIONS

#### PATAS / LEGS / PIEDES

7,5 P-24 7 P-12

#### ACABADOS / FINISHES / FINITIONS

P-12	WENGUE		
P-12	CEREZO	CHERRY	MERISIER
P-24	CROMADO	CHROMED	CHROMÉ

#### DESGLIZANTE / SLIDING / AMOVIBLE

- Deslizante mediante mecanismo automático con botonera cromada o mando inalámbrico.
- Automatic sliding system, with chromed buttons or remote control.
- Coulissant avec mécanisme électrique ayant deux options : boutonnière chromée ou télécommande.

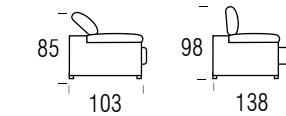

## COOL

34-35



OP1



OP2

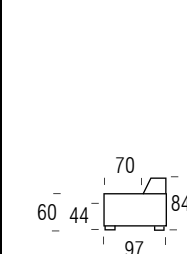

OP1

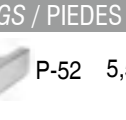
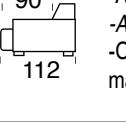
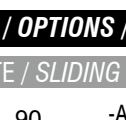
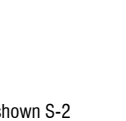
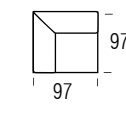
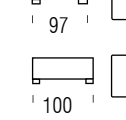
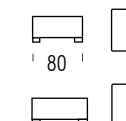
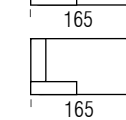
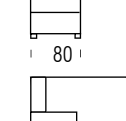
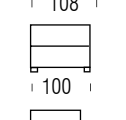
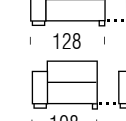
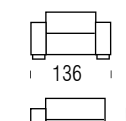
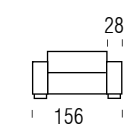

OP2

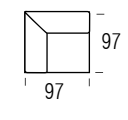
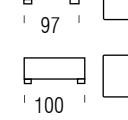
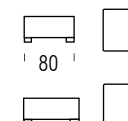
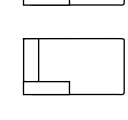
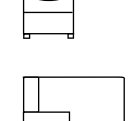
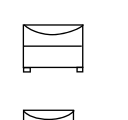
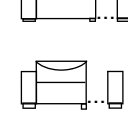
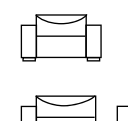
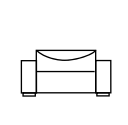

REF.

201EP

2011P

201ME

201M1

201ES

2011S

201CH

201CS

201PF

201PR

201PA

201RI

\*Fabric model shown S-2

### OPCIONES / OPTIONS / OPTIONS

#### DESGLIZANTE / SLIDING / AMOVIBLE

- Asiento deslizante automático con mando inalámbrico.
- Automatic sliding system with remote control.
- Coulissant avec mécanisme électrique ayant télécommande.

#### PATAS / LEGS / PIEDES

5,5 P-52 5,5 P-25 4 P-42

HIDE / OCULTA

#### ACABADOS / FINISHES / FINITIONS

P-25	P-42	WENGUE	
P-25		CEREZO	CHERRY
		ROBLE	OAK
P-52		CROMADO	CHROMED
			CHROMÉ

#### DESENFUNDABLE / REMOVABLE / DEHOUSSABLE

**DEMO**

42-43

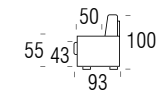

	OP1 30	OP2 20	REF.
			<b>1894P</b>
			<b>1893P</b>
			<b>1892P</b>
			<b>189EP</b>
			<b>1891P</b>
			<b>189M4</b>
			<b>189M3</b>
			<b>189M2</b>
			<b>189ME</b>
			<b>189M1</b>
			<b>1894S</b>
			<b>1893S</b>
			<b>1892S</b>
			<b>189ES</b>
			<b>1891S</b>
			<b>189CH</b>
			<b>189CS</b>
			<b>189PF</b>
			<b>189RI</b>

\*Fabric model shown S-4

**OPCIONES / OPTIONS / OPTIONS**

**PATAS / LEGS / PIEDES**



**ASIENTOS / SEATS / ASSISE**

- LISO SIN CAPITONÉ / SMOOTH SEAT / LISSE SANS CAPITONNÉ



**DESIZANTE / SLIDING / AMOVIBLE**

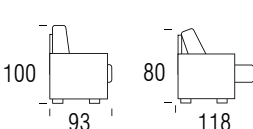

- Asiento y respaldo deslizante manual.
- Manual sliding system for seat and back.
- Assie et dossier amovible manual.
- Deslizante mediante mecanismo automático con botonera cromada o mando inalámbrico.
- Automatic sliding system, with chromed buttons or remote control.
- Couissant avec mécanisme électrique ayant deux options : boutonnière chromée ou télécommande.

**DESK**

48-49

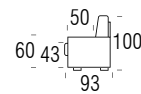

	REF.	REF.
	<b>1925P</b>	<b>1925S</b>
	<b>1924P</b>	<b>1924S</b>
	<b>1923P</b>	<b>1923S</b>
	<b>1922P</b>	<b>1922S</b>
	<b>192EP</b>	<b>192ES</b>
	<b>1921P</b>	<b>1921S</b>
	<b>192M5</b>	<b>192CH</b>
	<b>192M4</b>	<b>192CS</b>
	<b>192M3</b>	<b>192CR</b>
	<b>192M2</b>	<b>192RI</b>
	<b>192ME</b>	
	<b>192M1</b>	

\*Fabric model shown S-2

**OPCIONES / OPTIONS / OPTIONS**

**PATAS / LEGS / PIEDES**



**ASIENTOS / SEATS / ASSISE**



**DESIZANTE / SLIDING / AMOVIBLE**

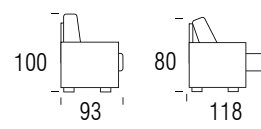

- Asiento y respaldo deslizante manual.
- Manual sliding system for seat and back.
- Assie et dossier amovible manual.
- Deslizante mediante mecanismo automático con botonera cromada o mando inalámbrico.
- Automatic sliding system, with chromed buttons or remote control.
- Couissant avec mécanisme électrique ayant deux options : boutonnière chromée ou télécommande.

**EGOS**

30-31

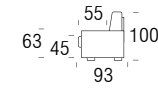

	OP1 18	OP2 12	REF.
			<b>1905P</b>
			<b>1904P</b>
			<b>1903P</b>
			<b>1902P</b>
			<b>190EP</b>
			<b>1901P</b>
			<b>190M5</b>
			<b>190M4</b>
			<b>190M3</b>
			<b>190M2</b>
			<b>190ME</b>
			<b>190M1</b>
			<b>1905S</b>
			<b>1904S</b>
			<b>1903S</b>
			<b>1902S</b>
			<b>190ES</b>
			<b>1901S</b>
			<b>190CH</b>
			<b>190CS</b>
			<b>190CR</b>
			<b>190PF</b>
			<b>190RI</b>
			<b>190RR</b>

\*Fabric model shown S-2

**OPCIONES / OPTIONS / OPTIONS**

**PATAS / LEGS / PIEDES**



**ASIENTOS / SEATS / ASSISE**



**DESIZANTE / SLIDING / AMOVIBLE**

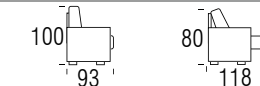

- Asiento y respaldo deslizante.
- Sliding system for seat and back.
- Assie et dossier amovible.

**EMUC**

16-19

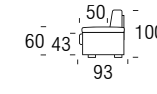

	OP1 30	OP2 20	REF.
			<b>1785P</b>
			<b>1784P</b>
			<b>1783P</b>
			<b>1782P</b>
			<b>178EP</b>
			<b>1781P</b>
			<b>178M5</b>
			<b>178M4</b>
			<b>178M3</b>
			<b>178M2</b>
			<b>178ME</b>
			<b>178M1</b>
			<b>1785S</b>
			<b>1784S</b>
			<b>1783S</b>
			<b>1782S</b>
			<b>178ES</b>
			<b>1781S</b>
			<b>178CH</b>
			<b>178CS</b>
			<b>178CR</b>
			<b>178PF</b>
			<b>178RI</b>
			<b>178RR</b>

\*Fabric model shown S-2

**OPCIONES / OPTIONS / OPTIONS**

**PATAS / LEGS / PIEDES**



**ASIENTOS / SEATS / ASSISE**



**DESIZANTE / SLIDING / AMOVIBLE**

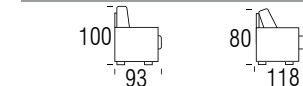

- Asiento y respaldo deslizante.
- Sliding system for seat and back.
- Assie et dossier amovible.

**LIEB**

4-7



REF.

2034P

2033P

2032P

2031P

203M4

203M3

203M2

203ME

203M1

2034S

2033S

2032S

203ES

2031S

203CH

203CS

203PF

203RI

\*Fabric model shown S-2

**OPCIONES / OPTIONS / OPTIONS**

**PATAS / LEGS / PIEDES**

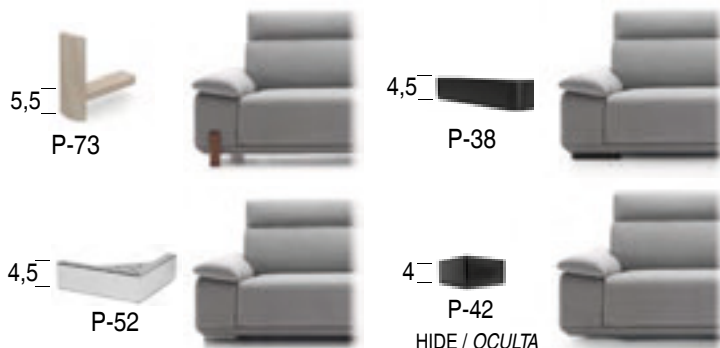

**ASIENTO / SEAT / ASSISE**

GOMA / FOAM / MOUSSE

**LIME**

12-15



REF.

9194P

9193P

9192P

919M4

919M3

919M2

9194S

9193S

9192S

919CH

919CS

919PF

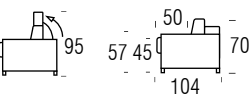

- Respaldo abatible.  
- Fold back system.  
- Abattable.

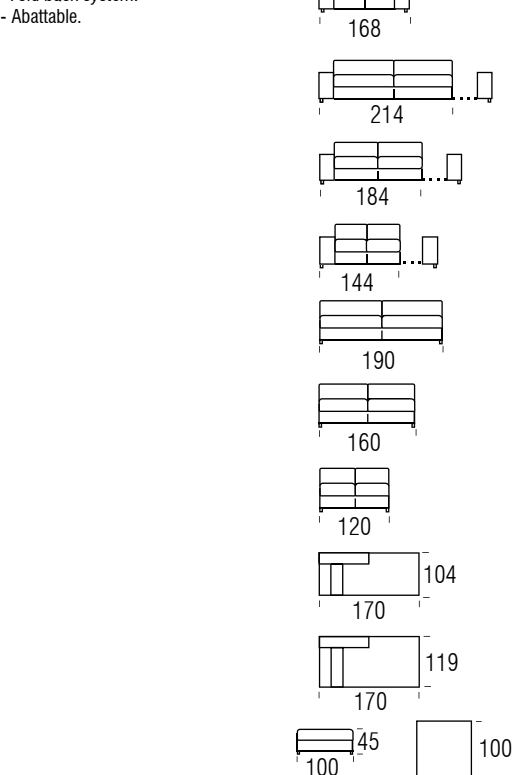

\*Fabric model shown S-3

**OPCIONES / OPTIONS / OPTIONS**

**PATAS / LEGS / PIEDES**



**ACABADOS / FINISHES / FINITIONS**

P-67	WENGUE		
P-67	CEREZO	CHERRY	MERISIER
P-67	ROBLE	OAK	CHÊNE
P-28 P-14	CROMADO	CHROMED	CHROMÉ

**LOBI**

24-25



REF.

1914P

1913P

1912P

1911P

191M4

191M3

191M2

191M1

1914S

1913S

1912S

1911S

191CH

191CS

191PF

191RI

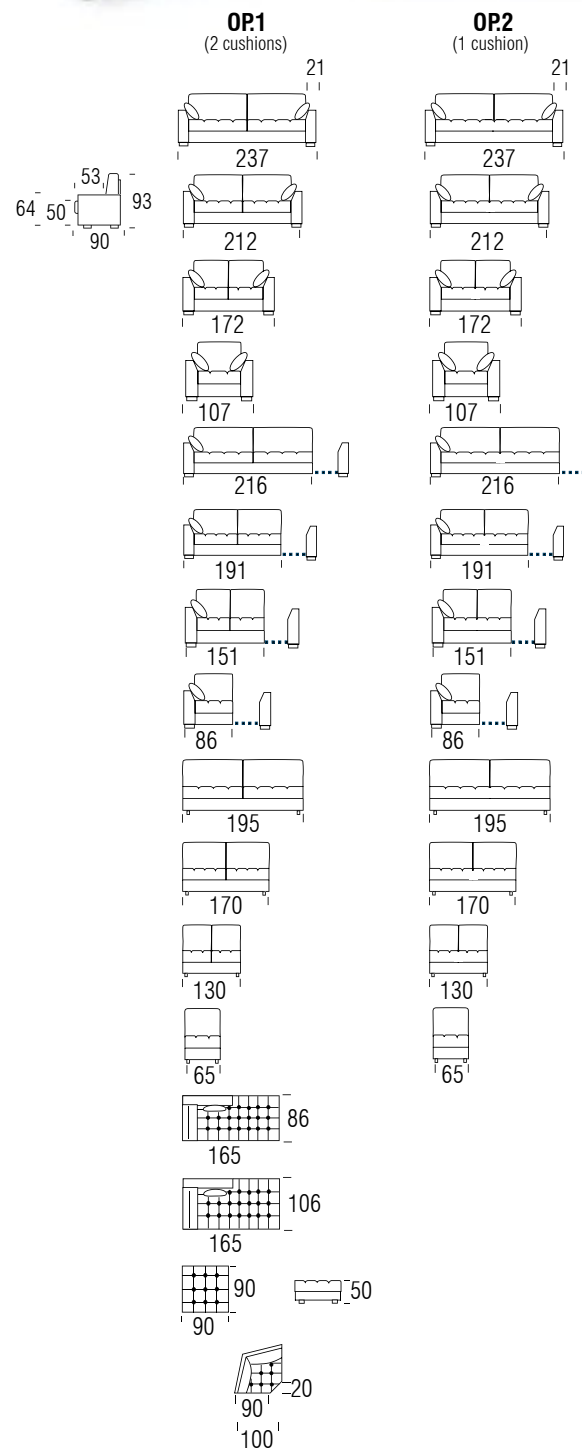

\*Fabric model shown S-4

**OPCIONES / OPTIONS / OPTIONS**

**PATAS / LEGS / PIEDES**



**ACABADOS / FINISHES / FINITIONS**

P-12	WENGUE		
P-12	CEREZO	CHERRY	MERISIER
P-2	CROMADO	CHROMED	CHROMÉ

**ASIENTOS / SEATS / ASSISE**

- LISO SIN CAPITONÉ.  
- SMOOTH SEAT.  
- LISSE SANS CAPITONNÉ

**MARE**

53-54



REF.

1404P

1403P

1402P

140EP

1401P

140M4

140M3

140M2

140ME

140M1

1404S

1403S

1402S

140ES

1401S

140CH

140CS

140CR

140RI

\*Fabric model shown S-2

**OPCIONES / OPTIONS / OPTIONS**

**PATAS / LEGS / PIEDES**



**ASIENTOS / SEATS / ASSISE**



**DESILZANTE / SLIDING / AMOVIBLE**

- Asiento y respaldo deslizable manual.  
- Manual sliding system for seat and back.  
- Assie et dossier amovible manual.

- Deslizable mediante mecanismo automático con botonera cromada o mando inalámbrico.  
- Automatic sliding system, with chromed buttons or remote control.

- Coulissant avec mécanisme électrique ayant deux options : boutonnière chromée ou télécommande.

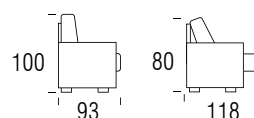

**MODO**

38-39

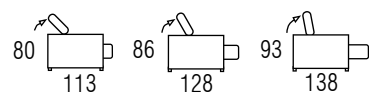

REF.

1564P

1563P

1562P

1561P

156M4

156M3

156M2

156M1

1564S

1563S

1562S

1561S

156CH

156CR

156RI

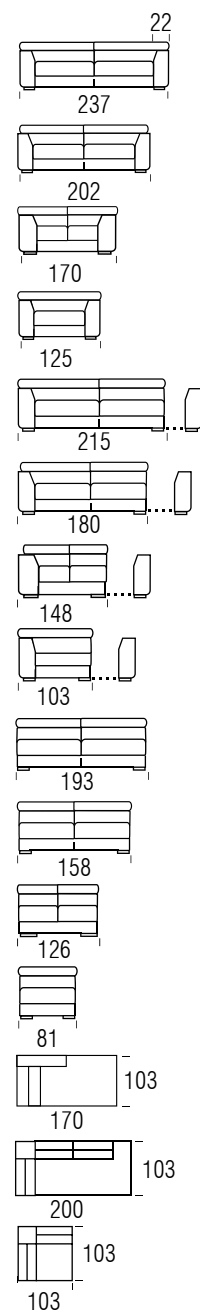

Deslizante manual incluido. Respaldo abatible.  
Manual sliding system included. Folding back system.  
Assise amovible. Dossier abattable.

\*Fabric model shown S-2

**OPCIONES / OPTIONS / OPTIONS**

**PATAS / LEGS / PIEDES**



**ACABADOS / FINISHES / FINITIONS**

P-25	WENGUE		
P-25	CEREZO	CHERRY	MERISIER
P-25	ROBLE	OAK	CHÊNE
P-23	CROMADO	CHROMED	CHROMÉ

**CABEZAL / HEADREST / APPUI-TÊTE**

**BRAZO / ARM / BRAS**

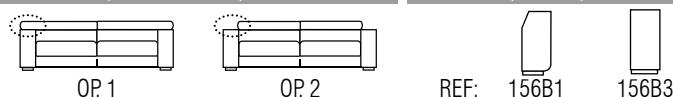

**DESILIZANTE / SLIDING / AMOVIBLE**

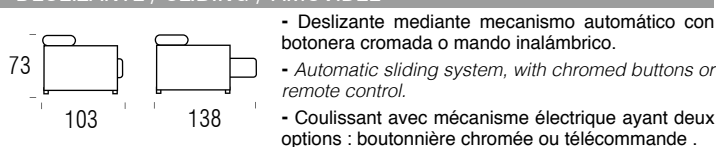

- Deslizante mediante mecanismo automático con botonera cromada o mando inalámbrico.  
- Automatic sliding system, with chromed buttons or remote control.  
- Couissant avec mécanisme électrique ayant deux options : boutonnière chromée ou télécommande.

**MUSA**

54-57

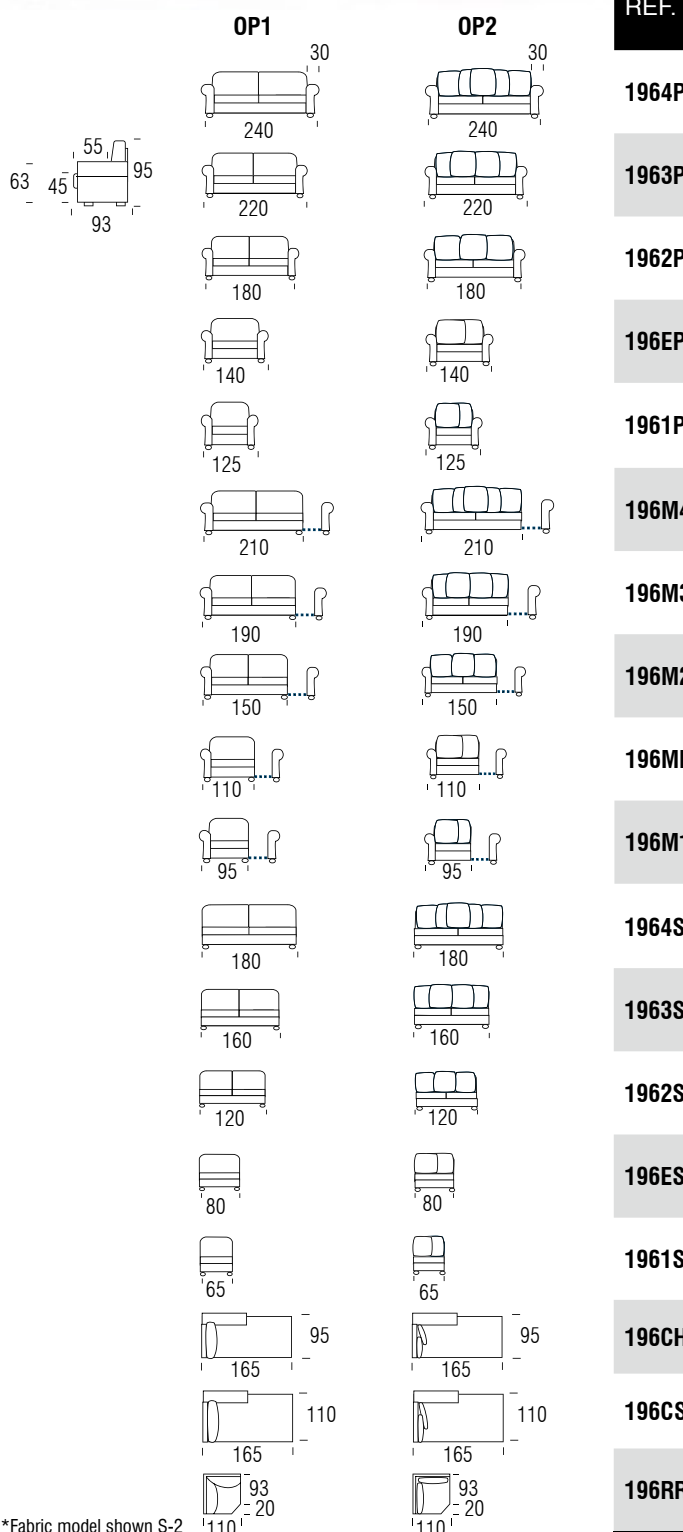

REF.

1964P

1963P

1962P

196EP

1961P

196M4

196M3

196M2

196ME

196M1

1964S

1963S

1962S

196ES

1961S

196CH

196CS

196RR

\*Fabric model shown S-2

**OPCIONES / OPTIONS / OPTIONS**

**PATAS / LEGS / PIEDES**



**ACABADOS / FINISHES / FINITIONS**

P-34, P-33	WENGUE
P-34, P-33	CEREZO / CHERRY / MERISIER
P-34, P-33	PAN DE ORO / GOLD LEAF / OR
P-34, P-33	PAN DE PLATA / SILVER LEAF / ARGENT
P-34, P-33	NEGRO BRILLO / SHINE BLACK / NOIR BRILLANT
P-34, P-33	BLANCO BRILLO / SHINE WHITE / BLANC BRILLIANT

**ASIENTOS / SEATS / ASSISE**



**DESENFUNDABLE / REMOVABLE / DEHOUSABLE**

**MYMA**

58-59

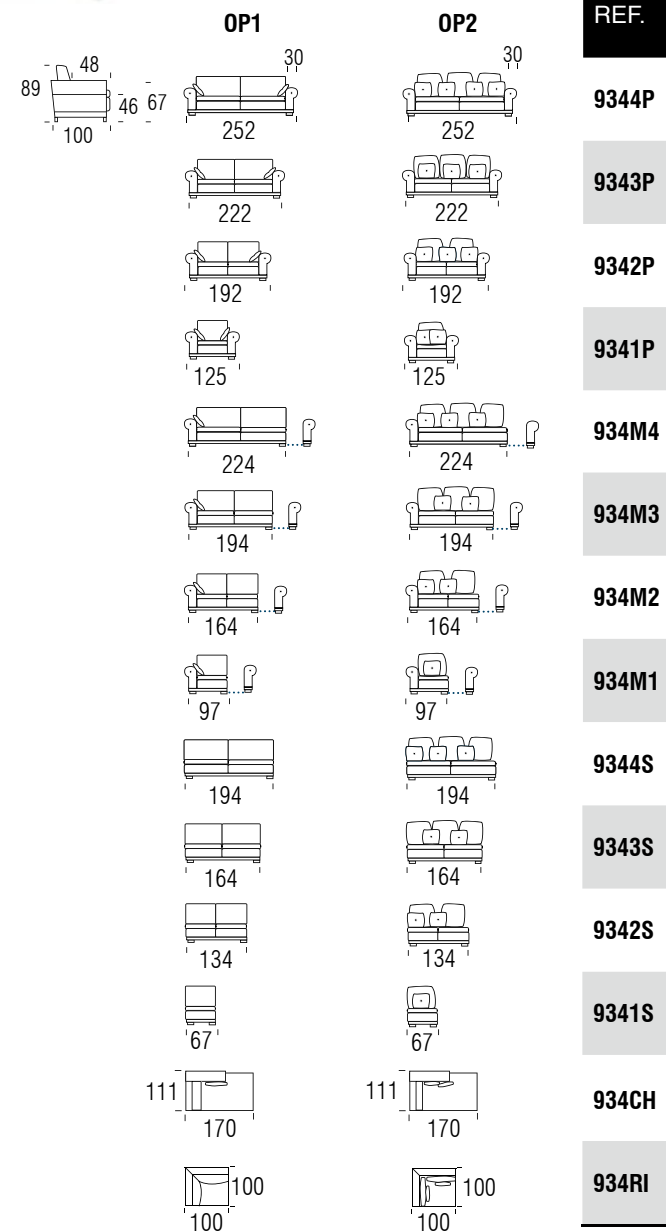

REF.

9344P

9343P

9342P

9341P

934M4

934M3

934M2

934M1

9344S

9343S

9342S

9341S

934CH

934RI

\*Fabric model shown S-3

**OPCIONES / OPTIONS / OPTIONS**

**PATAS / LEGS / PIEDES**



**ACABADOS / FINISHES / FINITIONS**

P-34, P-33	WENGUE
P-34, P-33	CEREZO / CHERRY / MERISIER
P-34, P-33	PAN DE ORO / GOLD LEAF / OR
P-34, P-33	PAN DE PLATA / SILVER LEAF / ARGENT
P-34, P-33	NEGRO BRILLO / SHINE BLACK / NOIR BRILLANT
P-34, P-33	BLANCO BRILLO / SHINE WHITE / BLANC BRILLIANT

**SWAROSKI ELEMENTS**

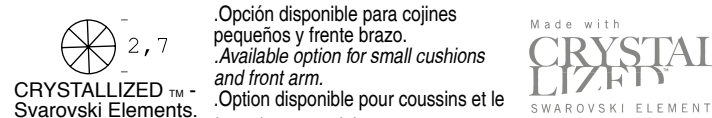

**FONDO ESPECIAL / SPECIAL DEPTH / PROFONDEUR SPECIALE**

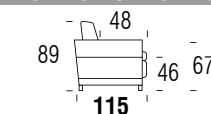

**NIMO**

26-29

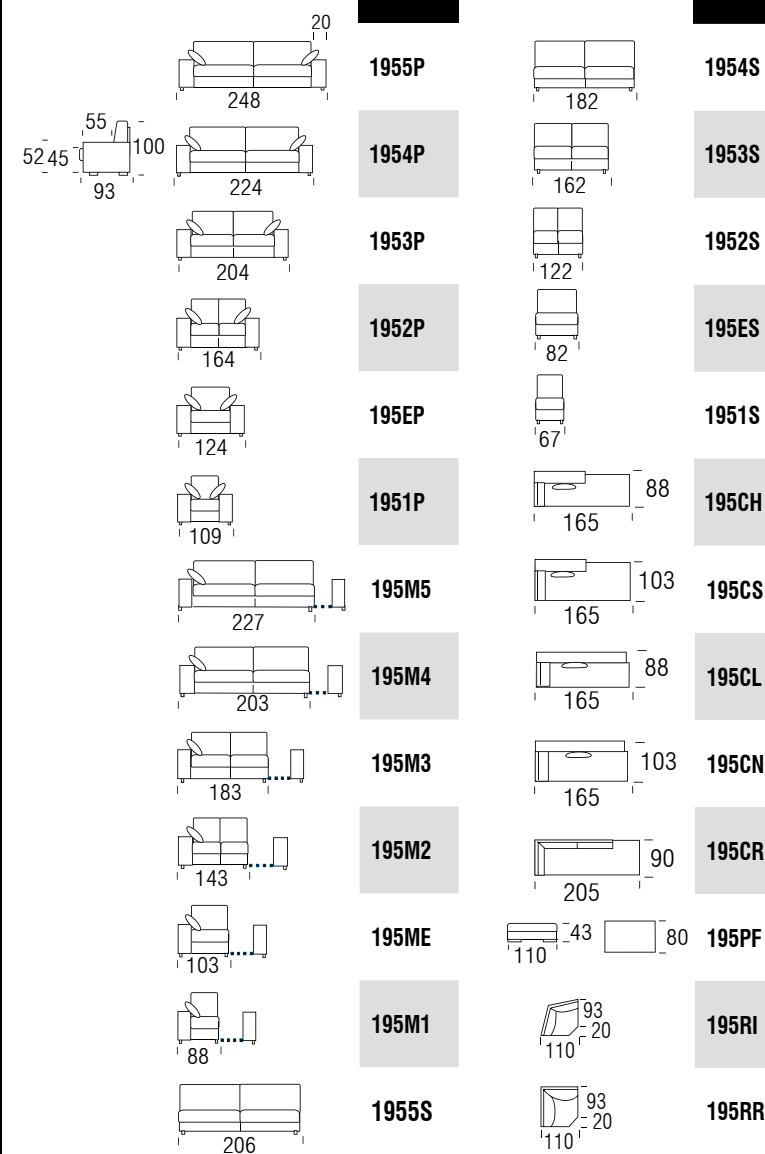

REF.

1955P

1954P

1953P

1952P

195EP

1951P

195M5

195M4

195M3

195M2

195ME

195M1

1955S

REF.

1954S

1953S

1952S

195ES

1951S

195CH

195CS

195CL

195CN

195CR

195PF

195RI

195RR

\*Fabric model shown S-2

**OPCIONES / OPTIONS / OPTIONS**

**PATAS / LEGS / PIEDES**



**ACABADOS / FINISHES / FINITIONS**

P-25	P-42	WENGUE		
P-25	CEREZO	CHERRY	MERISIER	
P-25	ROBLE	OAK	CHÊNE	
P-52	CROMADO	CHROMED	CHROMÉ	

**ASIENTOS / SEATS / ASSISE**

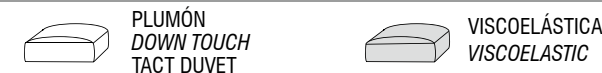

**DESILIZANTE / SLIDING / AMOVIBLE**

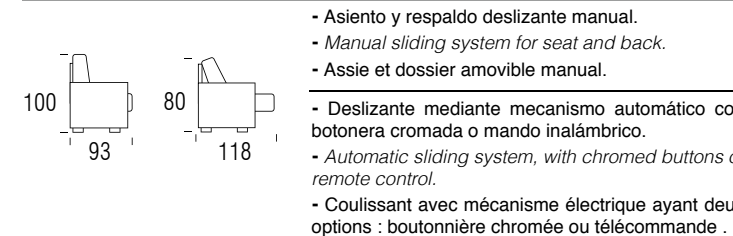

- Asiento y respaldo deslizante manual.  
- Manual sliding system for seat and back.  
- Assie et dossier amovible manual.  
- Deslizante mediante mecanismo automático con botonera cromada o mando inalámbrico.  
- Automatic sliding system, with chromed buttons or remote control.  
- Couissant avec mécanisme électrique ayant deux options : boutonnière chromée ou télécommande.

**NOVO**

44-47

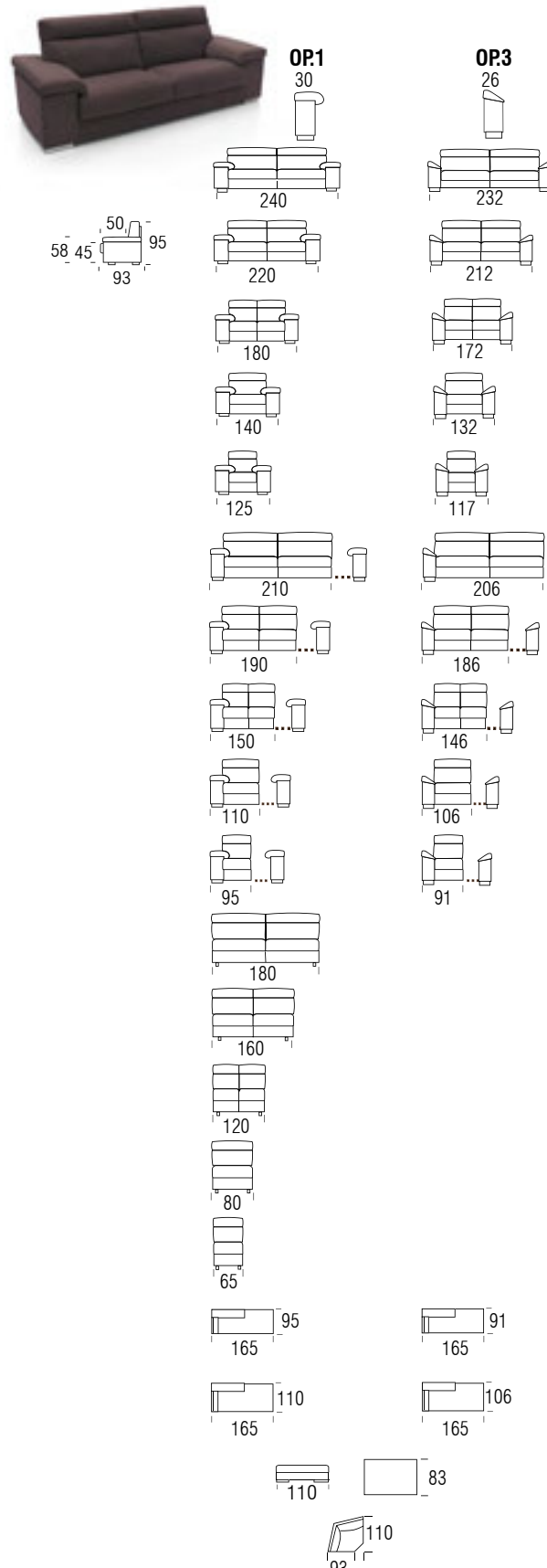

\*Fabric model shown S-2

**OPCIONES / OPTIONS / OPTIONS**

**PATAS / LEGS / PIEDES**



**ASIENTOS / SEATS / ASSISE**



**DESIZANTE / SLIDING / AMOVIBLE**

- Asiento y respaldo deslizante manual.
- Manual sliding system for seat and back.
- Assie et dossier amovible manual.
- Deslizante mediante mecanismo automático con botonera cromada o mando inalámbrico.
- Automatic sliding system, with chromed buttons or remote control.
- Coulissant avec mécanisme électrique ayant deux options : boutonnière chromée ou télécommande.

**NUMA**

60-61

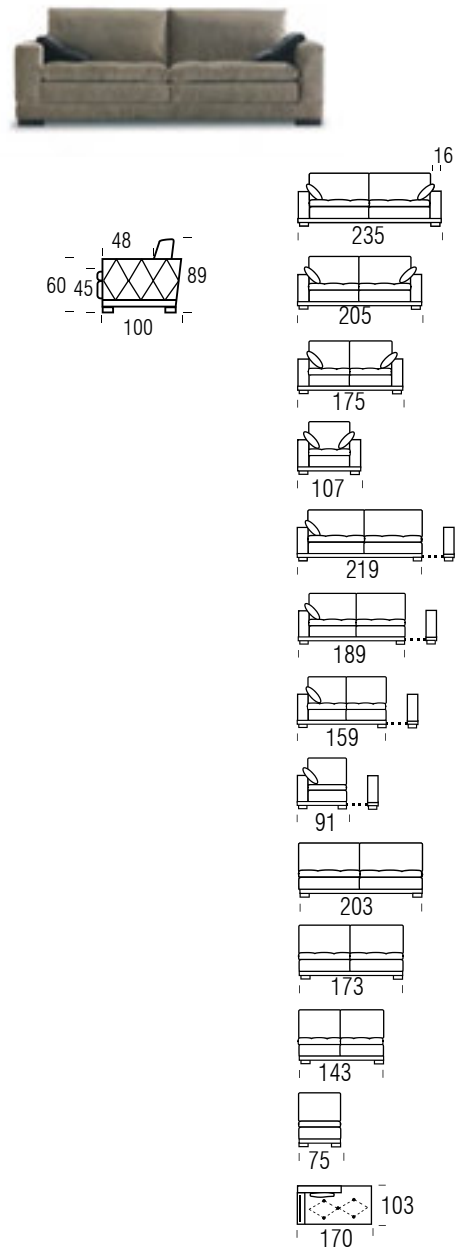

\*Fabric model shown S-3

**OPCIONES / OPTIONS / OPTIONS**

**PATAS / LEGS / PIEDES**



**ACABADOS / FINISHES / FINITIONS**

- P-25 WENGUE
- P-25 CEREZO / CHERRY / MERISIER
- P-25 PAN DE ORO / GOLD LEAF / OR
- P-25 PAN DE PLATA / SILVER LEAF / ARGENT
- P-25 NEGRO BRILLO / SHINE BLACK / NOIR BRILLANT
- P-25 BLANCO BRILLO / SHINE WHITE / BLANC BRILLIANT
- P-23 CROMADO / CHROME / CROMÉ

**SWAROSKI ELEMENTS**



**FONDO ESPECIAL / SPECIAL DEPTH / PROFONDEUR SPECIALE**

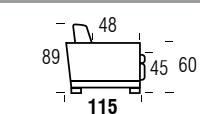

**LISO / SMOOTH / LISSE**

- Sin capitoné en brazos ni rombos en asientos.
- Smooth without quilted buttons in arms and seat.
- Sans capitoné dans les assises et pas losanges dans les accoudoirs.

**NOHA**

32-33

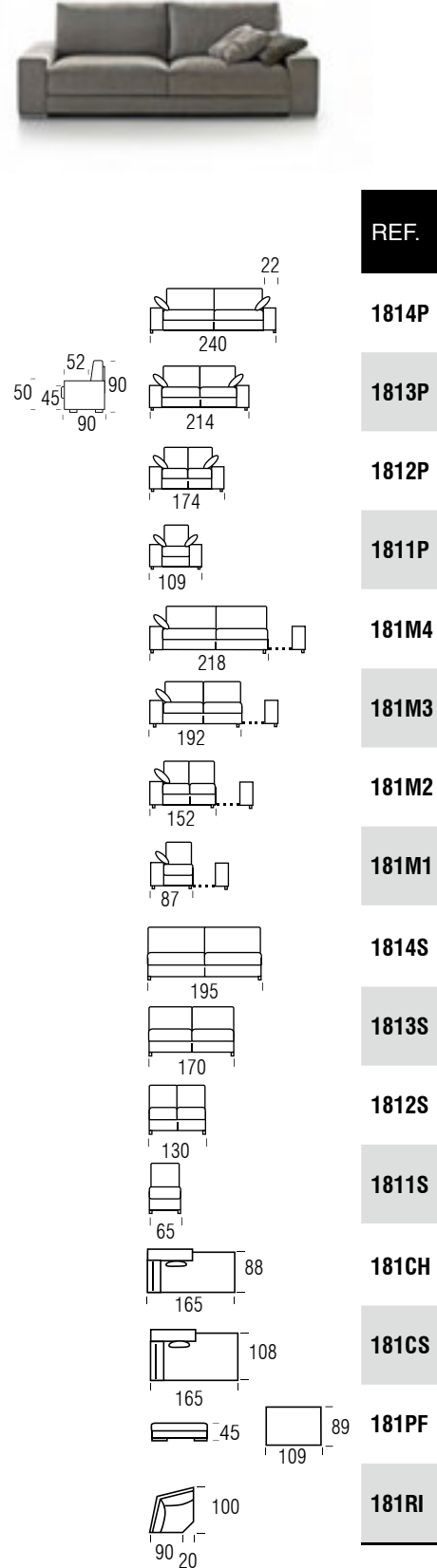

\*Fabric model shown S-3

**OPCIONES / OPTIONS / OPTIONS**

**PATAS / LEGS / PIEDES**

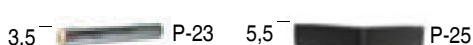

HIDE / OCULTA

**ACABADOS / FINISHES / FINITIONS**

- P-25 P-42 WENGUE
- P-25 CEREZO CHERRY MERISIER
- P-25 ROBLE OAK CHÈNE
- P-23 CROMADO CHROMED CHROMÉ

**SIMA**

36-37

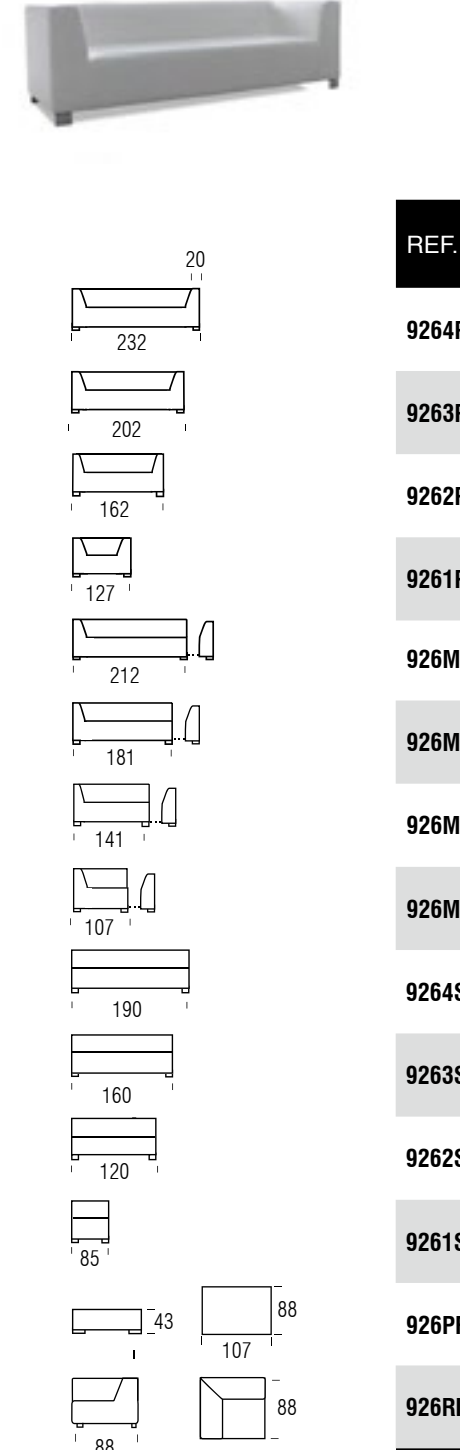

\*Fabric model shown S-3

**OPCIONES / OPTIONS / OPTIONS**

**PATAS / LEGS / PIEDES**



**ACABADOS / FINISHES / FINITIONS**

- P-12 WENGUE
- P-12 CEREZO CHERRY MERISIER
- P-2 CROMADO CHROMED CHÈNE

**SOUL**

8-11

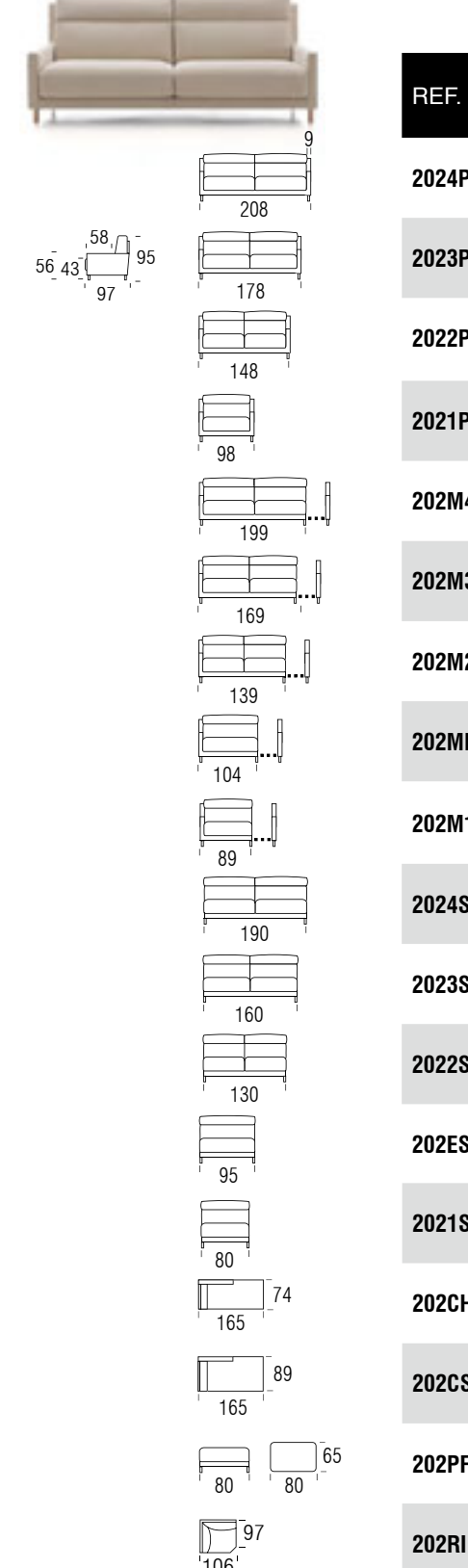

\*Fabric model shown S-2

**OPCIONES / OPTIONS / OPTIONS**

**PATAS / LEGS / PIEDES**



**ACABADOS / FINISHES / FINITIONS**

- P-68 WENGUE
- P-68 ROBLE OAK CHÈNE
- P-68 NOGAL WALNUT NOYER
- P-15 CROMADO CHROMED CHROMÉ
- P-15 NEGRO BLACK NOIR

**ASIENTO / SEAT / ASSISE**



**VOLL**

62-64



REF. 2041R

RELAX AUTOMÁTICO  
AUTOMATIC RECLINER

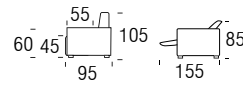

SOFA CAMA  
SOFA BED

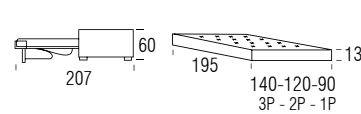

SOFA  
SOFA

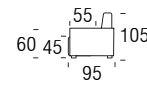

OP.1	OP.2	REF.
220	210	<b>2044R</b>
		<b>2043R</b>
200	190	
		<b>2042R</b>
160	150	
		<b>2041R</b>
198	193	
		<b>2044D</b>
178	173	
		<b>2043D</b>
138	133	
		<b>2042D</b>
110	105	
		<b>204ED</b>
100	95	
		<b>2041D</b>

**FONT**

65



REF.

**1871P**

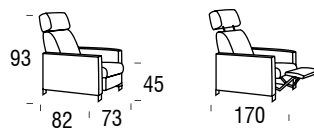

\*Fabric model shown S-2

**OPCIONES / OPTIONS / OPTIONS**

COLCHÓN / MATTRESS / MATELAS

- ESPUMA / FOAM / MOUSSE.
- MUELLES / INTERIOR SPRING / RESSORT
- VISCOELÁSTICA / VISCOELASTIC / MÉMOIRE.

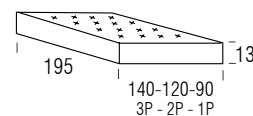

**OPCIONES / OPTIONS / OPTIONS**

PATAS / LEGS / PIEDES



ACABADOS / FINISHES / FINITIONS

P-72	WENGUE		
P-72	CEREZO	CHERRY	MERISIER
P-72	ROBLE	OAK	CHÊNE
P-71	CROMADO	CHROMED	CHROMÉ

**NICE**

68-69

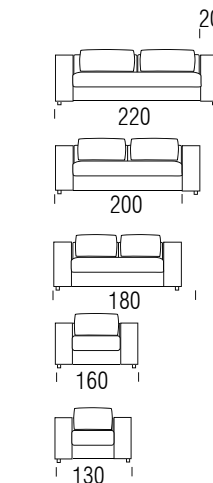
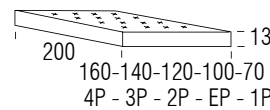

\*Fabric model shown S-2

**OPCIONES / OPTIONS / OPTIONS**

COLCHÓN / MATTRESS / MATELAS

- ESPUMA / FOAM / MOUSSE.
- VISCOELÁSTICA / VISCOELASTIC / MÉMOIRE.

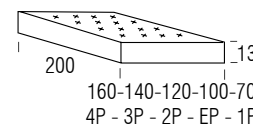

PATAS / LEGS / PIEDES

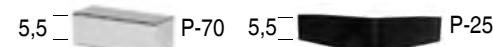

ACABADOS / FINISHES / FINITIONS

P-25	WENGUE		
P-25	CEREZO	CHERRY	MERISIER
P-25	ROBLE	OAK	CHÊNE
P-70	CROMADO	CHROMED	CHROMÉ

**EROC**

66-67



SOFA CAMA / SOFA BED / CONVERTIBLE

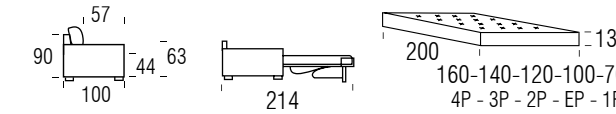

OP.1	OP.2	OP.3	OP.4	REF.
220	202	234		<b>6794P</b>
				<b>6793P</b>
200	182	214		
				<b>6792P</b>
180	162	194		
				<b>679EP</b>
160	142	174		
				<b>6791P</b>
130	112	144		
				<b>679M4</b>
200	202	234		
				<b>679M3</b>
180	182	214		
				<b>679M2</b>
160	162	194		
				<b>679ME</b>
140	142	174		
				<b>679M1</b>
110	112	144		

SOFA FIJO / SOFA / CANAPÉ

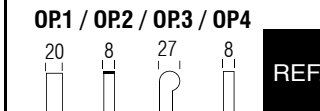
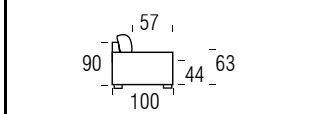

MEDIDAS IGUALES /  
SAME MEASURES /  
DIMENSION SIMILAIRE

OP.1 / OP.2 / OP.3 / OP.4	REF.
	<b>6794F</b>
	<b>6793F</b>
	<b>6792F</b>
	<b>679EF</b>
	<b>6791F</b>
	<b>679F4</b>
	<b>679F3</b>
	<b>679F2</b>
	<b>679FE</b>
	<b>679F1</b>

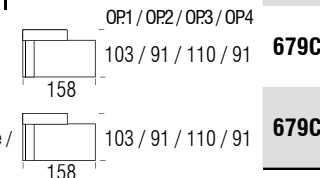

Chaise longue con arcón /  
Chaise longue with storage /  
Chaise longue avec coffre

\*Fabric model shown S-2

**OPCIONES / OPTIONS / OPTIONS**

SISTEMA DE RUEDAS EXTRAIBLES / WHEEL REMOVABLE SYSTEM / SYSTÈME DE ROUES AMOVIBLE



Mecanismo de elevación por el que con tan solo accionar la palanca aparecen unas ruedas que elevan el sofá cama y permiten desplazarlo fácilmente. /  
Using the lever of the lifting system, wheels appear and elevate the sofa which allow to move it easily. /  
Mécanisme d'élevation selon lequel il faut seulement lever le levier pour avoir des roues qui soulèvent le canapé-lit et vous permettent de le déplacer facilement.

COLCHÓN / MATTRESS / MATELAS

- ESPUMA / FOAM / MOUSSE.
- VISCOELÁSTICA / VISCOELASTIC / MÉMOIRE.

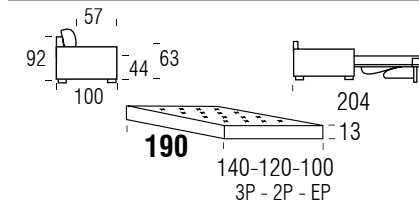
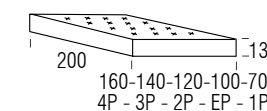

PATAS / LEGS / PIEDES



**ADOC**

75

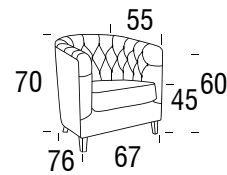

REF.

680BU

\*Fabric model shown S-2

**OPCIONES / OPTIONS / OPTIONS**

**ACABADOS / FINISHES / FINITIONS**

WENGUE

CEREZO	CHERRY	MERISIER
ROBLE	OAK	CHÊNE
BLANCO	WHITE	BLANC
NEGRO	MATT BLACK	NOIR

**ALMA**

70

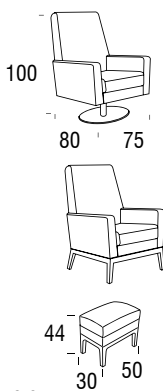

REF.

194BU

194BZ

194PF

\*Fabric model shown S-2

**OPCIONES / OPTIONS / OPTIONS**

**ACABADOS / FINISHES / FINITIONS**

194BZ	WENGUE		
194BZ	CEREZO	CHERRY	MERISIER
194BZ	ROBLE	OAK	CHÊNE
194BU	ACERO	STEEL	ACIER

**ALZA**

77

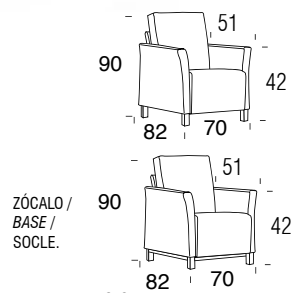

REF.

309BU

309BZ

\*Fabric model shown S-2

**OPCIONES / OPTIONS / OPTIONS**

**PATAS / LEGS / PIEDES**



**ACABADOS / FINISHES / FINITIONS**

P-21	WENGUE		
P-21	CEREZO	CHERRY	MERISIER
P-21	ROBLE	OAK	CHÊNE
P-56	CROMADO	CHROMED	CHROMÉ

**CITY**

71

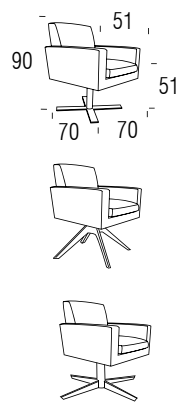

REF.

935BU

935BZ

935BC

\*Fabric model shown S-2

**OPCIONES / OPTIONS / OPTIONS**

**ACABADOS / FINISHES / FINITIONS**

328BZ	WENGUE		
328BZ	CEREZO	CHERRY	MERISIER
328BZ	FRESNO	ASH	FRESNE
328BZ	NOGAL	WALNUT	NOYER
328BU	ACERO INOX	STAINLESS STEEL	ACIER INOX
328BC (STEEL)	BLANCO	WHITE	BLANC
328BC (STEEL)	NEGRO	BLACK	NOIR

DESENFUNDABLE / REMOVABLE / DEHOUSSABLE

**IOVA**

74

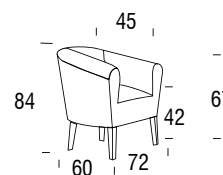

REF.

197BU

\*Fabric model shown S-2

**OPCIONES / OPTIONS / OPTIONS**

**ACABADOS / FINISHES / FINITIONS**

WENGUE

CEREZO	CHERRY	MERISIER
ROBLE	OAK	CHÊNE
BLANCO	WHITE	BLANC
NEGRO	BLACK	NOIR

**LASE**

73

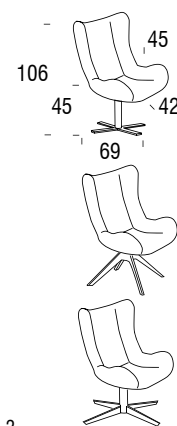

REF.

328BU

328BZ

328BC

\*Fabric model shown S-2

**OPCIONES / OPTIONS / OPTIONS**

**ACABADOS / FINISHES / FINITIONS**

328BZ	WENGUE		
328BZ	CEREZO	CHERRY	MERISIER
328BZ	FRESNO	ASH	FRESNE
328BZ	NOGAL	WALNUT	NOYER
328BU	ACERO INOX	STAINLESS STEEL	ACIER INOX
328BC (STEEL)	BLANCO	WHITE	BLANC
328BC (STEEL)	NEGRO	BLACK	NOIR

**MAYA**

78

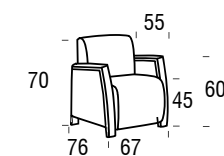

REF.

147BU

\*Fabric model shown S-2

**OPCIONES / OPTIONS / OPTIONS**

**ACABADOS / FINISHES / FINITIONS**

WENGUE

CEREZO	CHERRY	MERISIER
ROBLE	OAK	CHÊNE

**NAWA**

80

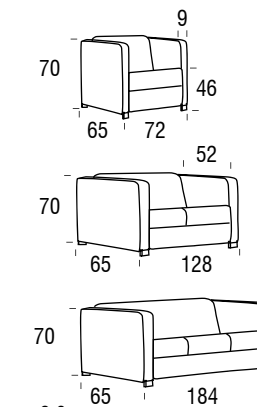

REF.

148BU

1482P

1483P

\*Fabric model shown S-2

**OPCIONES / OPTIONS / OPTIONS**

**BRAZO DE MADERA / WOOD ARM / BRAS BOIS**



REF: 148BU 1482P 1483P

**ACABADOS / FINISHES / FINITIONS**

WENGUE		
CEREZO	CHERRY	MERISIER



**OFRE**

72



REF.

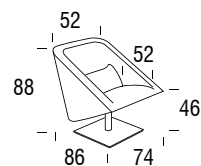

913BU

913BZ

\*Fabric model shown S-2

**OPCIONES / OPTIONS / OPTIONS**

**ACABADOS / FINISHES / FINITIONS**

913BU	ACERO INOX	STAINLESS STEEL	ACIER INOX
913BZ (STEEL)	BLANCO	WHITE	BLANC
913BZ (STEEL)	NEGRO	BLACK	NOIR

**SALO**

76



REF.

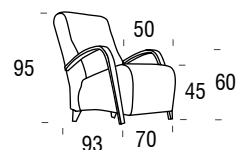

329BU

\*Fabric model shown S-2

**OPCIONES / OPTIONS / OPTIONS**

**ACABADOS / FINISHES / FINITIONS**

WENGUE		
CEREZO	CHERRY	MERISIER
ROBLE	OAK	CHÊNE
BLANCO	WHITE	BLANC
NEGRO	BLACK	NOIR

**TOMO**

79



REF.

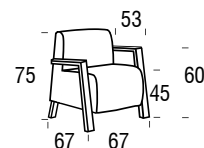

149BU

\*Fabric model shown S-2

**OPCIONES / OPTIONS / OPTIONS**

**ACABADOS / FINISHES / FINITIONS**

WENGUE		
CEREZO	CHERRY	MERISIER
ROBLE	OAK	CHÊNE

**VINA**

81



REF.

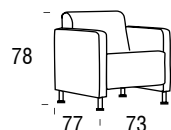

904BU

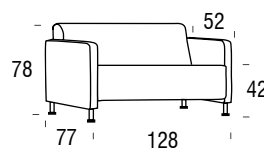

9042P

\*Fabric model shown S-2

**OPCIONES / OPTIONS / OPTIONS**

**PATAS / LEGS / PIEDES**



**CUBE**

88



REF.

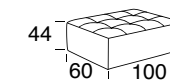

198PE

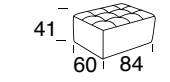

198PG

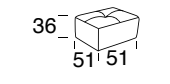

198PC

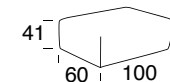

198PA

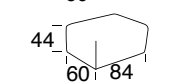

198PN

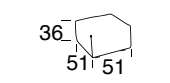

198PF

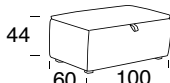

198PH

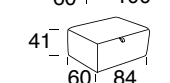

198PI

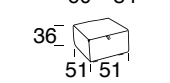

198PT

Capitoné  
Quilted  
Capitonne

Liso  
Smooth  
Lise

Arcon  
Container  
Coffre  
Tapa tapizada  
Upholstered lid  
Couvercle tapisse

\*Fabric model shown S-2

**PRAI**

89



REF.

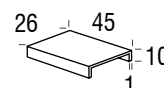

823CE

**OPCIONES / OPTIONS / OPTIONS**

**ACABADOS / FINISHES / FINITIONS**

WENGUE		
CEREZO	CHERRY	MERISIER
ROBLE	OAK	CHÊNE

**EASY**

89



Ref: 199RE  
50 cm



Ref: 199CO  
45x45 cm

REF.

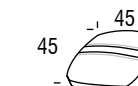

199CO

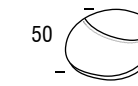

199RE

**CUSHIONS**

89



Ref: 141CO  
45x45 cm



Ref: 190CO  
37x47 cm



Ref: 195CO  
45x45 cm



Ref: REPOS



Ref: 184CO  
45x45 cm



Ref: 934CO  
45x45 cm



Ref: 913CO  
27x50 cm

REF.

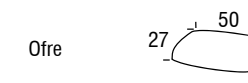

913CO

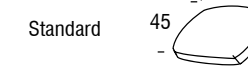

141CO

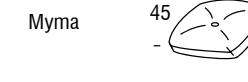

934CO

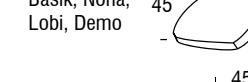

184CO

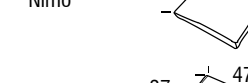

195CO



190CO



934CP



155CO



REPOS

ALO

82

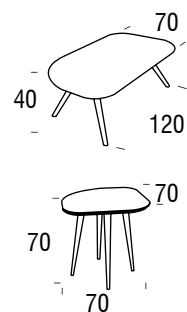

REF.

82318

82312

## OPCIONES / OPTIONS / OPTIONS

## ACABADOS / FINISHES / FINITIONS

WENGUE

NOGAL	WALNUT	NOYER
ROBLE	OAK	CHÊNE
NEGRO BRILLO O MATE	SHINE O MATT BLACK	NOIR BRILLIANT OU MAT
BLANCO BRILLO O MATE	SHINE O MATT WHITE	BLANC BRILLIANT OU MAT
ROJO BRILLO O MATE	SHINE O MATT RED	ROUGE BRILLIANT OU MAT

PAR

83



REF.

83512

83511

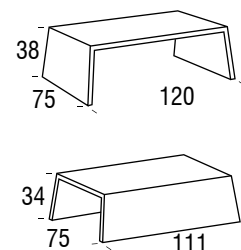

## OPCIONES / OPTIONS / OPTIONS

## ACABADOS / FINISHES / FINITIONS

WENGUE

NOGAL	WALNUT	NOYER
ROBLE	OAK	CHÊNE

GIB

85



OP1

OP2



REF.

80670

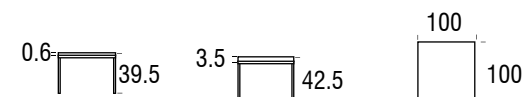

80610

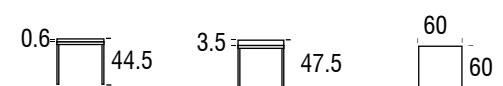

80660



80690

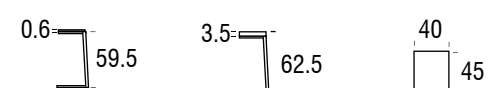

80640

## OPCIONES / OPTIONS / OPTIONS

## ACABADOS / FINISHES / FINITIONS

Indicar opción y acabado / Indicate option and finished / Indiquer une option et fine

## Estructura / Structure:

Estructura de acero:  
- Acero inoxidable AISI 304.  
- Lacado en negro, rojo o blanco.

Steel structure:  
- Stainless steel AISI 304.  
- Finishing colours black, red and white.

Structure en acier:  
- Acier inoxydable AISI 304.  
- Couleur de laqué noir, rouge, blanc.

OP1 ref: 806MC

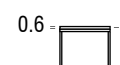

- Cristal templado: colores blanco, negro y transparente.  
- MDF chapado en roble.  
Acabado natural, cerezo, tinto en wengué.

- Tempered glass: in colours white, black and transparent.  
- MDF veneered in oak: natural finish, cherry, lacquered in wengué.

- Verre trempé, blanc, noir et transparent  
- MDF plaqué chêne, finition naturel, teinté wengué, merisier.

OP2 ref: 806MM

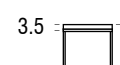

- MDF lacado: en los colores negro, rojo y blanco.  
- MDF chapado en roble.  
Acabado natural, cerezo, tinto en wengué.

- MDF lacquered: in black, red and white.  
- MDF veneered in oak: natural finish, cherry lacquered in wengué.

- MDF laqué, en couleurs noir, rouge et blanc.  
- MDF plaqué chêne, finition naturel, teinté wengué, merisier.

TAK

84

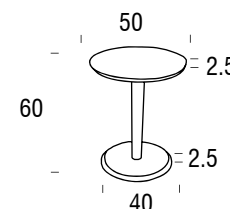

REF.

82450

## OPCIONES / OPTIONS / OPTIONS

## ACABADOS / FINISHES / FINITIONS

WENGUE

NOGAL	WALNUT	NOYER
ROBLE	OAK	CHÊNE
CEREZO	CHERRY	MERISIER

## TIP

86

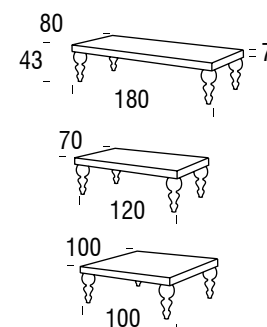

REF.

18018

18012

18010

## OPCIONES / OPTIONS / OPTIONS

## ACABADOS / FINISHES / FINITIONS

NEGRO BRILLO O MATE	SHINE O MATT BLACK	NOIR BRILLIANT OU MAT
BLANCO BRILLO O MATE	SHINE O MATT WHITE	BLANC BRILLIANT OU MAT
ROJO BRILLO O MATE	SHINE O MATT RED	ROUG BRILLIANT OU MAT
PAN DE PLATA	SILVER LEAF	ARGENT
PAN DE ORO	GOLD LEAF	OR

ZAR

87



OP1.

PATA COMPLETA

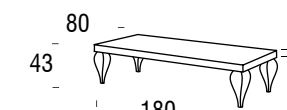

OP2.

PATA PARTIDA

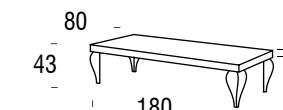

REF.

82218

82212

82210

## OPCIONES / OPTIONS / OPTIONS

## ACABADOS / FINISHES / FINITIONS

NEGRO BRILLO O MATE	SHINE O MATT BLACK	NOIR BRILLIANT OU MAT
BLANCO BRILLO O MATE	SHINE O MATT WHITE	BLANC BRILLIANT OU MAT
ROJO BRILLO O MATE	SHINE O MATT RED	ROUG BRILLIANT OU MAT
PAN DE PLATA	SILVER LEAF	ARGENT
PAN DE ORO	GOLD LEAF	OR

beltá

beltá &  
FRAJUMAR  
PROJECTS

FRAJUMAR

Poeta Francisco Antonio Gimenez, 33  
30510, Yecla, Murcia, Spain  
T: +34 968 719111  
F: +34 968 753690



info@beltafrajumar.com  
www.beltafrajumar.com  
www.frajumar.com  
www.belta.es



Facebook: FRAJUMAR Home Contract  
BELTÁ Home Contract



Twitter: @belta\_frajumar



You Tube: BELTÁ-FRAJUMAR's channel